

# UV Matrix CIS

COMMERCIAL IONIZATION SERIES

The UV Matrix CIS system is a perfect add on air ionization system for HVAC systems.

**Applications:**

- Nursing homes
- Animal facilities
- Cruise ships
- Manufacturing
- Doctors office
- Public spaces
- Schools
- Law enforcement
- Infectious disease wards
- Nail salons
- Smoking parlors
- Food service

**Technical Data**

Capacity	30-36 tons
Operating Voltage	24,120,208, 240,277 VAC 50/60 Hz.
Power Consumption	36 VA
Total ION Ouput	>1.92 Billion ions/ cc
Material	Aluminum / Carbon, probes.
Temp Range	-30-180 deg. F
Humidity Range	0-100% RH
Width	3 inches
Height	3 inches
length	49 inches
Probe length(x4)	3 inches
Product weight	7 Lbs.

Use separately or combine for larger systems

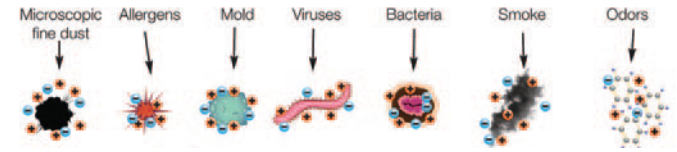

Ionization effectively reduces airborne

- Virus
- Bacteria
- Microscopic mold
- Smoke
- VOC (Volatile Organic Compounds)

Cut to fit 20 foot power lead included

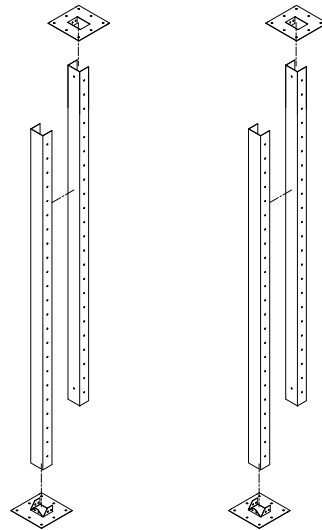
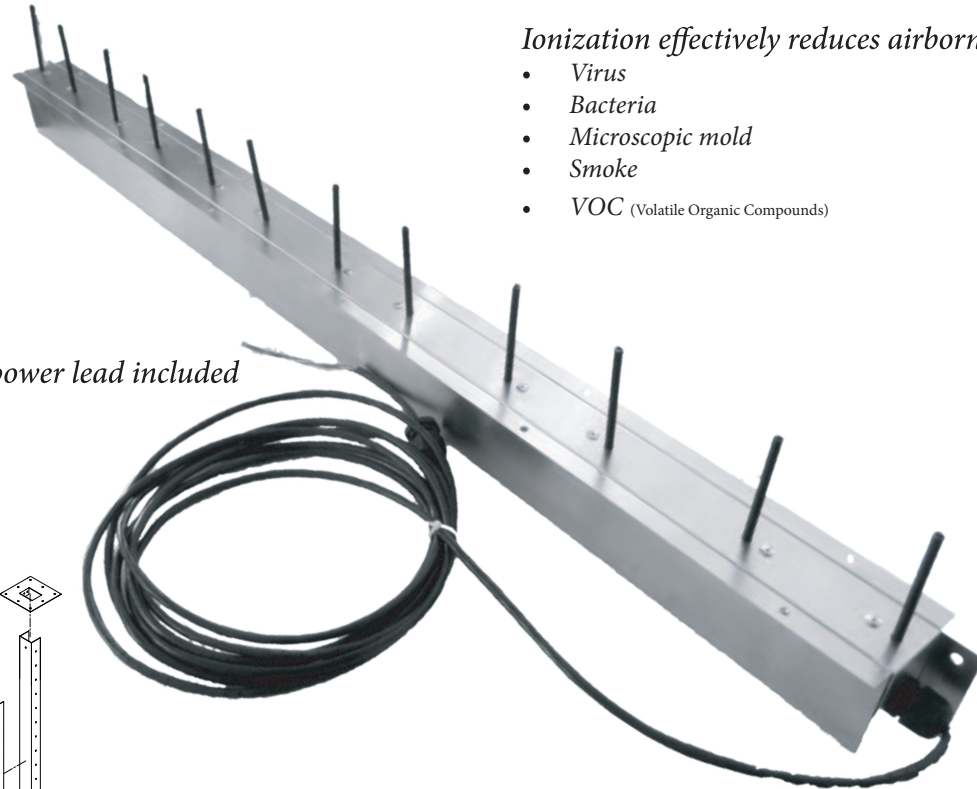

Optional VXP compatible for ease of installation



Product Sales Specification Sheet

Part Number	Description
UVMATRIX-CIS36	Air Ionization system 30-36 tons 24-277 VAC operation, 24 VAC transformer included.
-BIC option	Dry contacts for connection to Building automation
-SS option	For Housing to be manufactured out of 304 Stainless Steel
VXP-120	Vertical expansion post mounting system minimum of 2 required



# UV Matrix CIS

COMMERCIAL IONIZATION SERIES

The UV Matrix CIS system is a perfect add on air ionization system for HVAC systems. Optional magnet mount and flexible emitters allow for internal or external installation.

**Applications:**

- Nursing homes
- Animal facilities
- Cruise ships
- Manufacturing
- Doctors office
- Public spaces
- Schools
- Law enforcement
- Infectious disease wards
- Nail salons
- Smoking parlors
- Food service

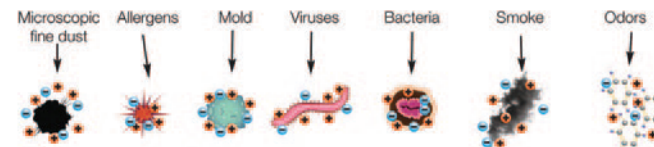

*Ionization effectively reduces airborne*

- Virus
- Bacteria
- Microscopic mold
- Smoke
- VOC (Volatile Organic Compounds)

**Technical Data**

Capacity	7-12 tons
Operating Voltage	24,120,208, 240,277 VAC 50/60 Hz.
Power Consumption	12 VA
Total ION Ouput	>640M ions/cc
Material	Galvanized,Steel/ Carbon, probes.
Temp Range	-30-180 deg. F
Humidity Range	0-100% RH
Width	11.5 inches
Height	4 inches
Depth	3 inches
Probe length(x4)	3 inches
Product weight	1.6 Lbs.
Warranty	5 years



Magnets supplied for Ease of internal mounting

**High Efficiency  
particle collection  
increases filtration  
capture ability**



**Ultravation**  
Better Air | Better Water | Better Living™

**Product Sales Specification Sheet**

Part Number	Description
UVMATRIX-CIS12	Air Ionization system 7-12 tons 24-277 VAC operation, 24 VAC transformer included.
-BIC option	Dry contacts for connection to Building automation
-SS option	for Housing to be manufactured out of 304 Stainless Steel



DC162021CIS1

866-468-8247 [ULTRAVATION.COM](http://ULTRAVATION.COM) [Sales@ultravation.com](mailto:Sales@ultravation.com)

# UV Matrix CIS

COMMERCIAL IONIZATION SERIES

The UV Matrix CIS system is a perfect add on air ionization system for HVAC systems. Optional magnet mount and flexible emitters allow for internal or external installation.

**Applications:**

- Nursing homes
- Animal facilities
- Cruise ships
- Manufacturing
- Doctors office
- Public spaces
- Schools
- Law enforcement
- Infectious disease wards
- Nail salons
- Smoking parlors
- Food service

**Technical Data**

Capacity	4-6 tons
Operating Voltage	24,120,208, 240,277 VAC 50/60 Hz.
Power Consumption	6 VA
Total ION Output	>320M ions/cc
Material	Galvanized, Steel/ Carbon, probes.
Temp Range	-30-180 deg. F
Humidity Range	0-100% RH
Width	5.75 inches
Height	4 inches
Depth	3 inches
Probe length(x2)	3 inches
Product weight	1 Lbs.
Warranty	5 years

*Rapid pulse ionization creates Millions of Positive and Negative IONS per second!*

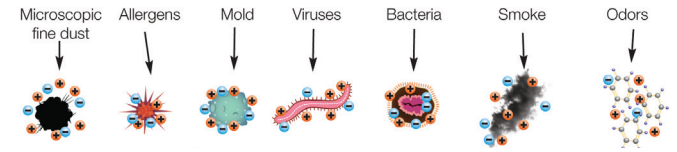

*Ionization effectively reduces airborne*

- Virus
- Bacteria
- Microscopic mold
- Smoke
- VOC (Volatile Organic Compounds)



Emitters move for external Mounting

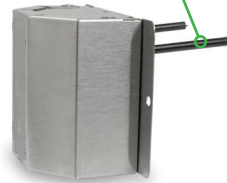

*Post filter option allows for increased contact time with VOC's and Airborne pathogens.*

*Providing both installations maximize performance as most filters neutralize the effects of the IONS.*

*Pre filter option allows for increased filter performance charging particles to clump together increasing filter capture!*

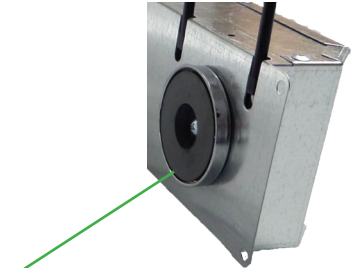

Magnets supplied for Ease of internal mounting



**Product Sales Specification Sheet**

Part Number	Description
UVMATRIX-CIS6	Air Ionization system 4-6 tons 24-277 VAC operation, 24 VAC transformer included.
-M option	Dry contacts for connection to Building automation
-SS option	for Housing to be manufactured out of 304 Stainless Steel

