

Specifications
Material: 22 ga. Domestic Aluminum (22 ga. Stainless Steel available)
Lamps: 2- 33" UVC lamps (Quartz sleeve for max thermal optimization)
Power Supply: 120-277v Outdoor Rated Electronic power supply
Power Consumption: 72 Watts
Electrical Housing: Water Tight Design
Note: Mounting hardware supplied

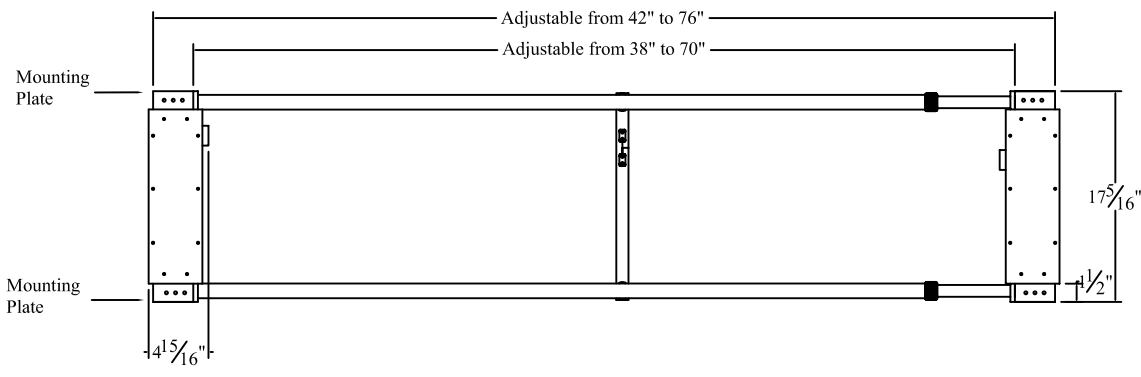
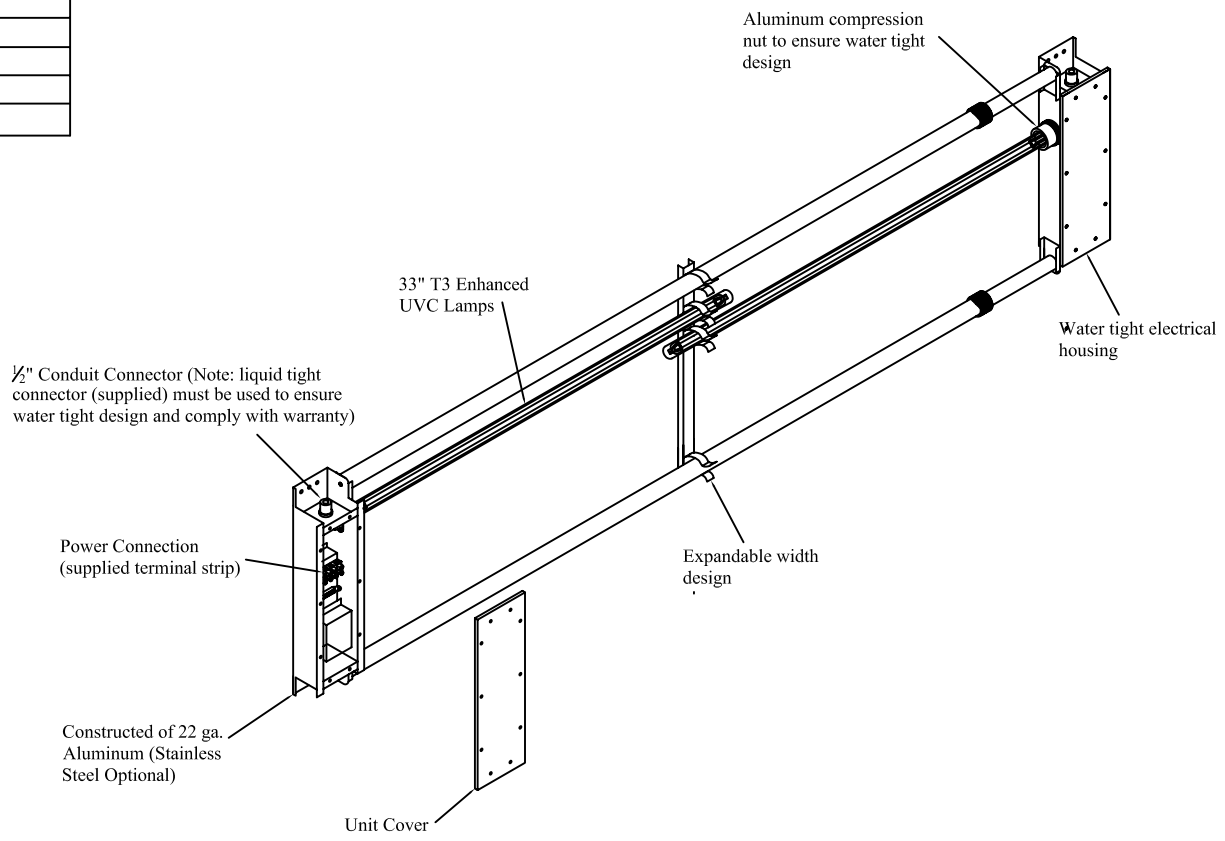

Ultravation, Inc. 212 Ideal Way Poultney, Vermont 05764 Ph: 802-287-9735 Fx: 802-287-9203 www.Ultravation.com	Part #:UV Matrix SI-2/G36	Drawing #:DC-IH-3343	Rev -A*
	Description: UVMatrix SI with 2 33" UVC lamps. Expandable width design. Water tight electrical housing. Power supply is auto sensing 120-277VAC		
	Date: 6/19/09	Scale:	Creator: JSM